

NG-PON Xpert™

Multi-layer Analyzer and Emulator
for Next Generation PONs



Multi-layer analysis of XG-PON1, XGS-PON and NG-PON2

Neutral Unbiased Testing of TC, OMCI and upper layer protocols

Multi-ONU Emulation and OLT Emulation options

NG-PON2 TWDM-PON support with dynamic wavelength switching

Complete Real-Time Analysis of Next Generation PON

Are you ready to test and analyze next generation PON technologies?

The NG-PON Xpert is a unique, real-time protocol analyzer for XG-PON1, XGS-PON and NG-PON2 networks and products, combined with a revolutionary Multi-ONU emulator as well as an OLT emulator with predefined and user-defined test cases.

Specifically designed for R&D, laboratory and field application engineers, NG-PON Xpert is a modular tool that helps operators and equipment vendors accelerate time-to-market by cutting significant time from development, deployment, debugging, troubleshooting and verification testing.

Multi-Layer Analysis

Using multi-layer probing capability, the NG-PON Xpert lays out a comprehensive picture of the protocols and traffic running through the PON. It analyzes and displays the Transmission Convergence (TC) and OMCI management layers and provides full analysis of the Upper Layers, including Ethernet, PPP, PPPoE, IPv4, IPv6, TCP, UDP, DHCP, IGMP, HTTP and TR-069.

Multi-ONU Emulation

The Multi-ONU Emulator module allows OLT vendors and service providers to test an OLT without requiring any ONU, while providing additional coverage for functions and options that are not fully covered by the traditional test setups of multiple ONUs.

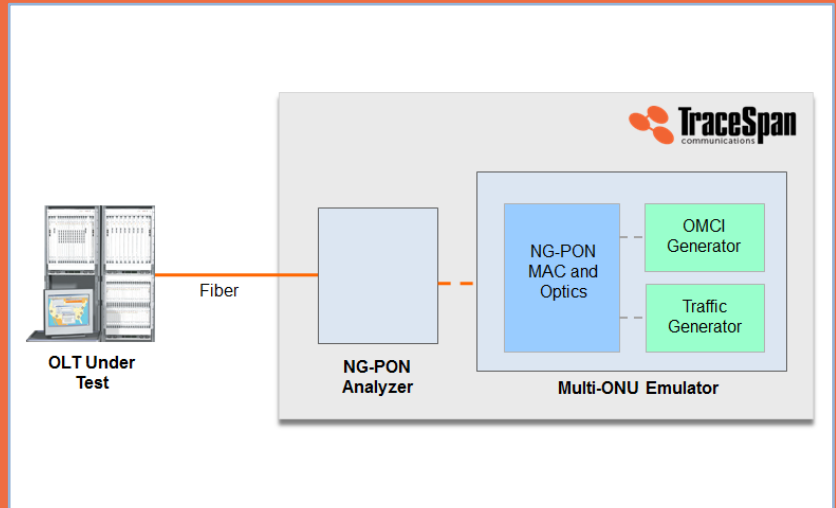

OLT Emulation

NG-PON Xpert can serve as an OLT Emulator for testing an ONU/ONT on a stand-alone basis, using predefined tests or user-defined ones. The OLT Emulator in the combined with the NG-PON analyzer and the built-in traffic generator provides an end-to-end ONU testing solution, which simultaneously generates commands and data, analyzes the ONU response, provides Pass/Fail indications for the tested steps and reports any non-compliance it detects.

TWDM NG-PON2 Support

NG-PON Xpert can support TWDM NG-PON2. Its unique wavelength switching mechanism allows it to individually select any of the 4 wavelengths in the downstream and any of the 4 wavelengths in the upstream. The wavelength selection is done by software and allows the NG-PON Xpert to dynamically switch from one set of wavelengths to another.

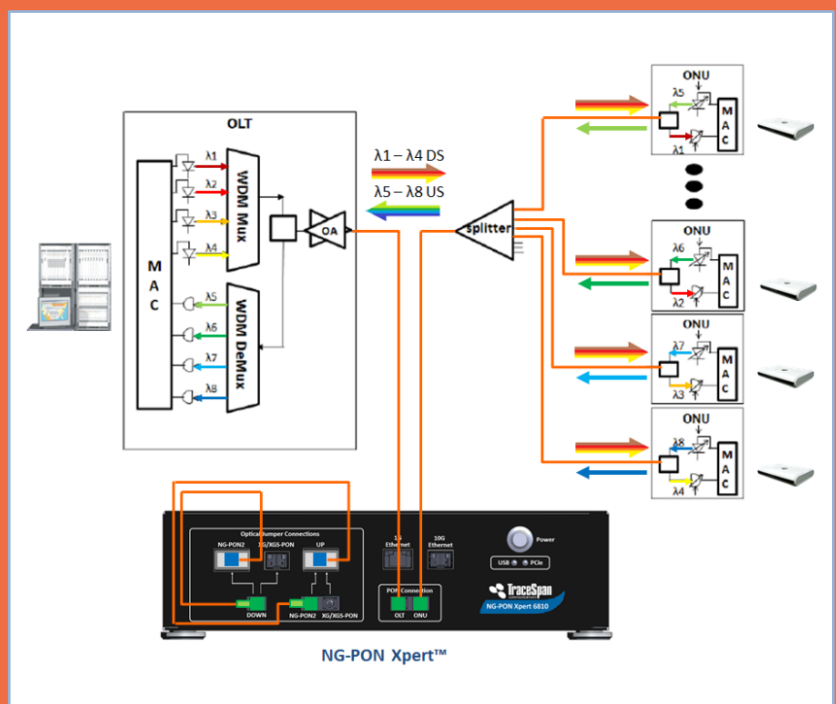

Intuitive User-Friendly Tool

NG-PON Xpert features a rich array of intuitive displays, graphs and tables for testing and troubleshooting of the PON components. The displayed information includes network topology, events, parsed messages of downstream and upstream data, data, OMCI relations diagrams, performance monitoring tools and connection links status between the OLT and the ONUs/ONTs.

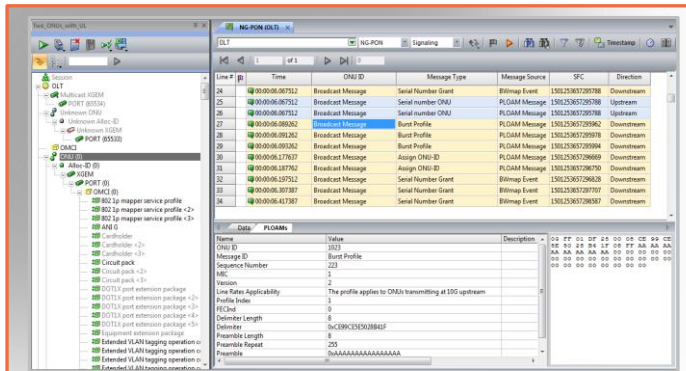

Information View
Network Tree, Data, Signaling and Events

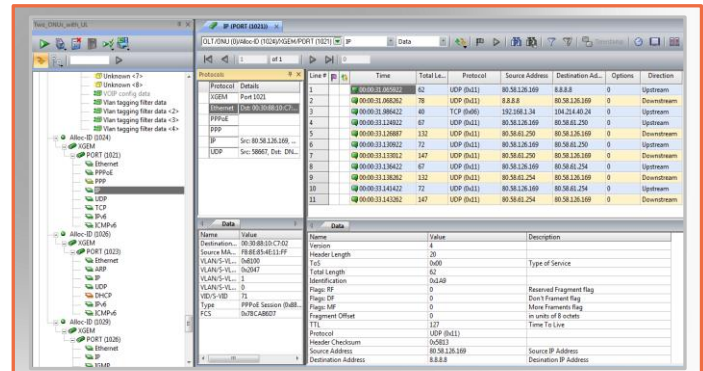

Upper Layer Analysis
Packet Contents and Events

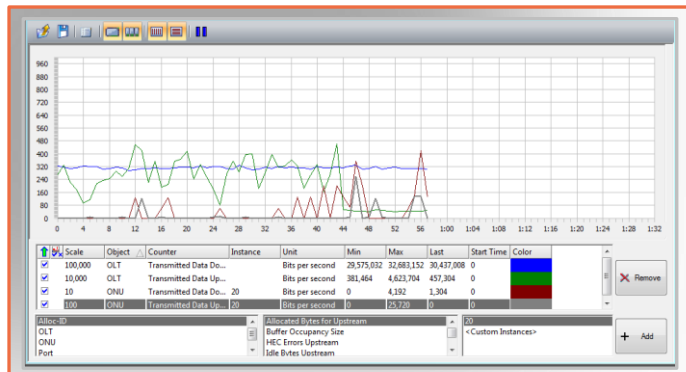

Performance Monitoring
Data Rates, Bandwidth Allocations and Error Rates

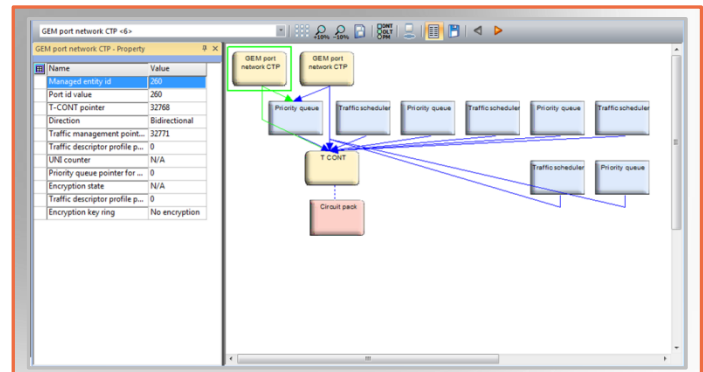

OMCI Analysis
Managed Entities and Relations Diagram

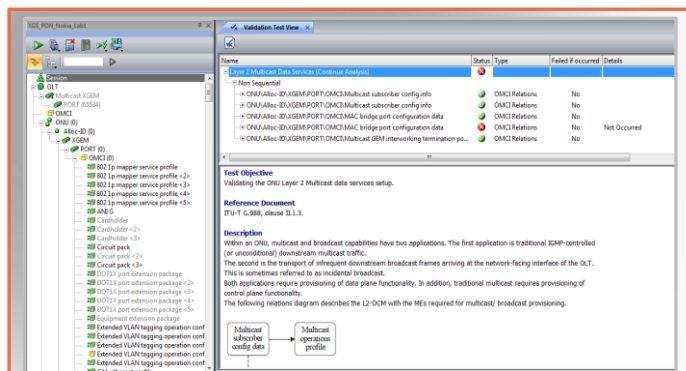

Validation Testing
Pass/Fail Results for Predefined and User-defined Test Procedures

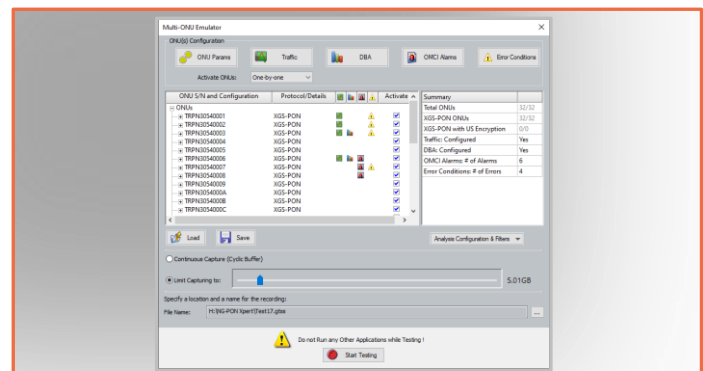

Multi-ONU Emulation
Emulation of Hundreds of ONUs for OLT Testing

Network Equipment Verification Testing

Ensuring proper operation of NG-PON network components enables equipment manufacturers and chipset developers to build high-quality products and shorten time-to-market. It also enables operators to provide reliable high-bandwidth services to their customers.

The innovative NG-PON Xpert analyzer clearly indicates abnormal behaviors and deviations from the relevant standards, thus verifying standard compliance and interoperability between different vendors' OLTs and ONUs/ONTs.

Extensive Reporting and Exporting Capabilities

NG-PON Xpert supports the automatic generation of detailed analysis reports in a user-friendly HTML format. Selected information can also be exported in various different formats such as PCAP and CSV.

Test Automation

The automated ONU test solution runs multiple tests in a sequence, thus speeding up the testing process, saving time and effort and minimizing human errors.

NG-PON Xpert also includes a Command Line Interface (CLI), enabling integration into an automated test environment, with a built-in tool for generation of the CLI commands.

Specifications

Standards Compatibility	G.987, G.987.1, G.987.2, G.987.3 – XG-PON Specifications G.9807.1 – XGS-PON Specifications G.989, G.989.1, G.989.2, G.989.3 – NG-PON2 Specifications G.988 – ONU Management and Control Interface (OMCI) BBF TR-156 BBF IR-247 ONU Conformance Test Plan
EMC Standards	FCC 47CFR Part 15, Subpart B, Class A EN 61326-1, Class A
Safety Standards	IEC 61010-1, EN 61010-1

For More Information

Visit: www.tracespan.com

Contact us: info@tracespan.com

Copyright © 2020 TraceSpan™ Communications Ltd. All rights reserved.
Product design and specifications are subject to change without notice.



Access Network Visibility